

200V Half Bridge Driver

PRODUCT SUMMARY

- V_{OFFSET} 200 V max.
- $I_{\text{O+/- (min)}}$ 130 mA/270 mA
- V_{OUT} 10 V - 20 V
- $t_{\text{on/off (typ.)}}$ 160 ns/220 ns
- **Delay Matching** 60 ns

GENERAL DESCRIPTION

The SLM2005S is a high voltage, high speed power MOSFET and IGBT drivers. Proprietary HVIC and latch immune CMOS technologies enable ruggedized monolithic construction. The logic input is compatible with standard CMOS or LSTTL output, down to 3.3 V logic. The output drivers feature a high pulse current buffer stage designed for minimum driver cross conduction. The floating channel can be used to drive an N-channel power MOSFET or IGBT in the high-side configuration which operates up to 200 V.

FEATURES

- Floating channel designed for bootstrap operation
- Fully operational to +200 V
- Tolerant to negative transient voltage, dV/dt immune
- Gate drive supply range from 10 V to 20 V
- Undervoltage lockout
- 3.3 V, 5 V, and 15 V logic compatible
- Cross-conduction prevention logic
- Matched propagation delay for both channels
- Outputs in phase with inputs
- RoHS compliant
- SOP8 package

TYPICAL APPLICATION CIRCUIT

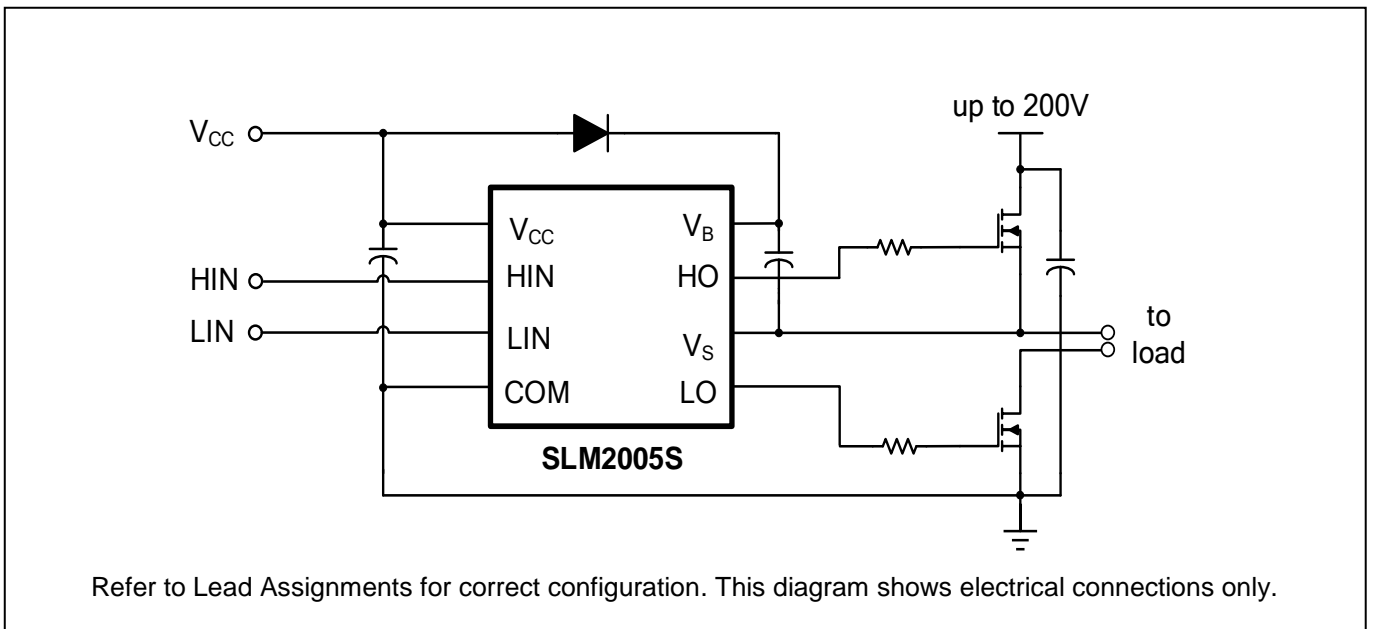

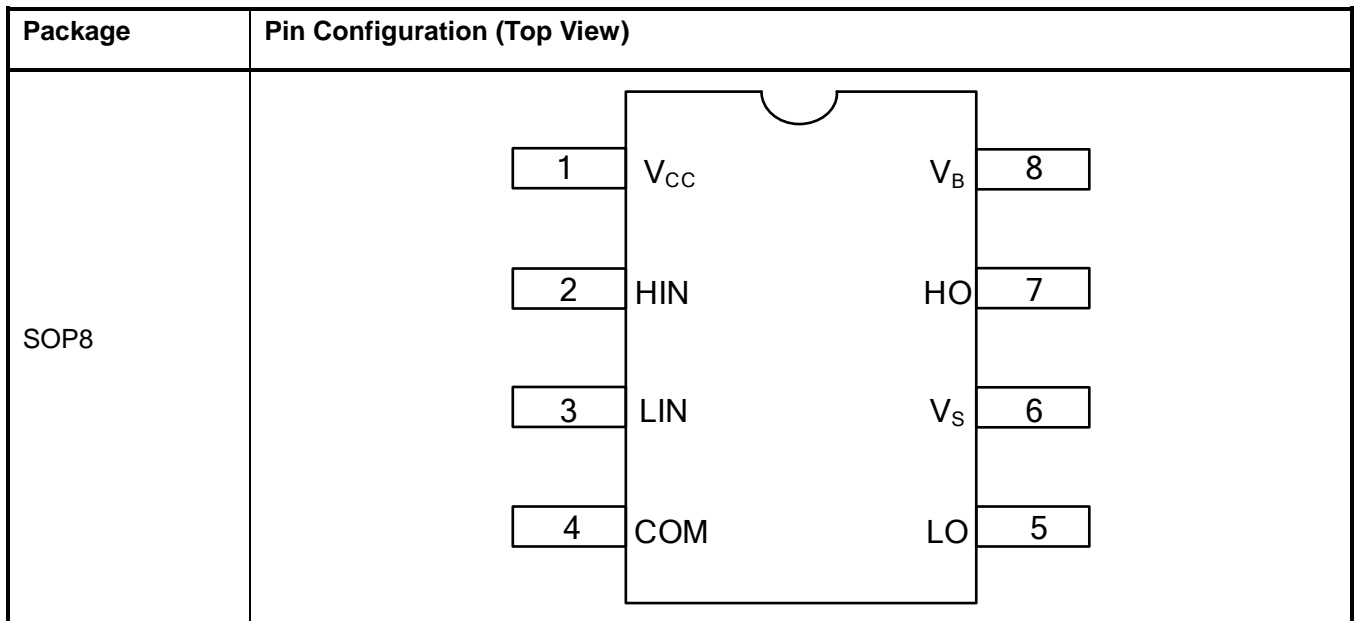
PIN CONFIGURATION

PIN DESCRIPTION

No.	Pin	Description
1	V _{cc}	Low-side and logic fixed supply
2	HIN	Logic input for high-side gate driver output (HO), in phase
3	LIN	Logic input for low-side gate driver output (LO), in phase
4	COM	Low-side return
5	LO	Low-side gate drive output
6	V _s	High-side floating supply return
7	HO	High-side gate drive output
8	V _b	High-side floating supply

ORDERING INFORMATION

Industrial Range: -40°C to +125°C

Order Part No.	Package	QTY
SLM2005SCA-13GTR	SOP8, Pb-Free	2500/Reel

FUNCTIONAL BLOCK DIAGRAM

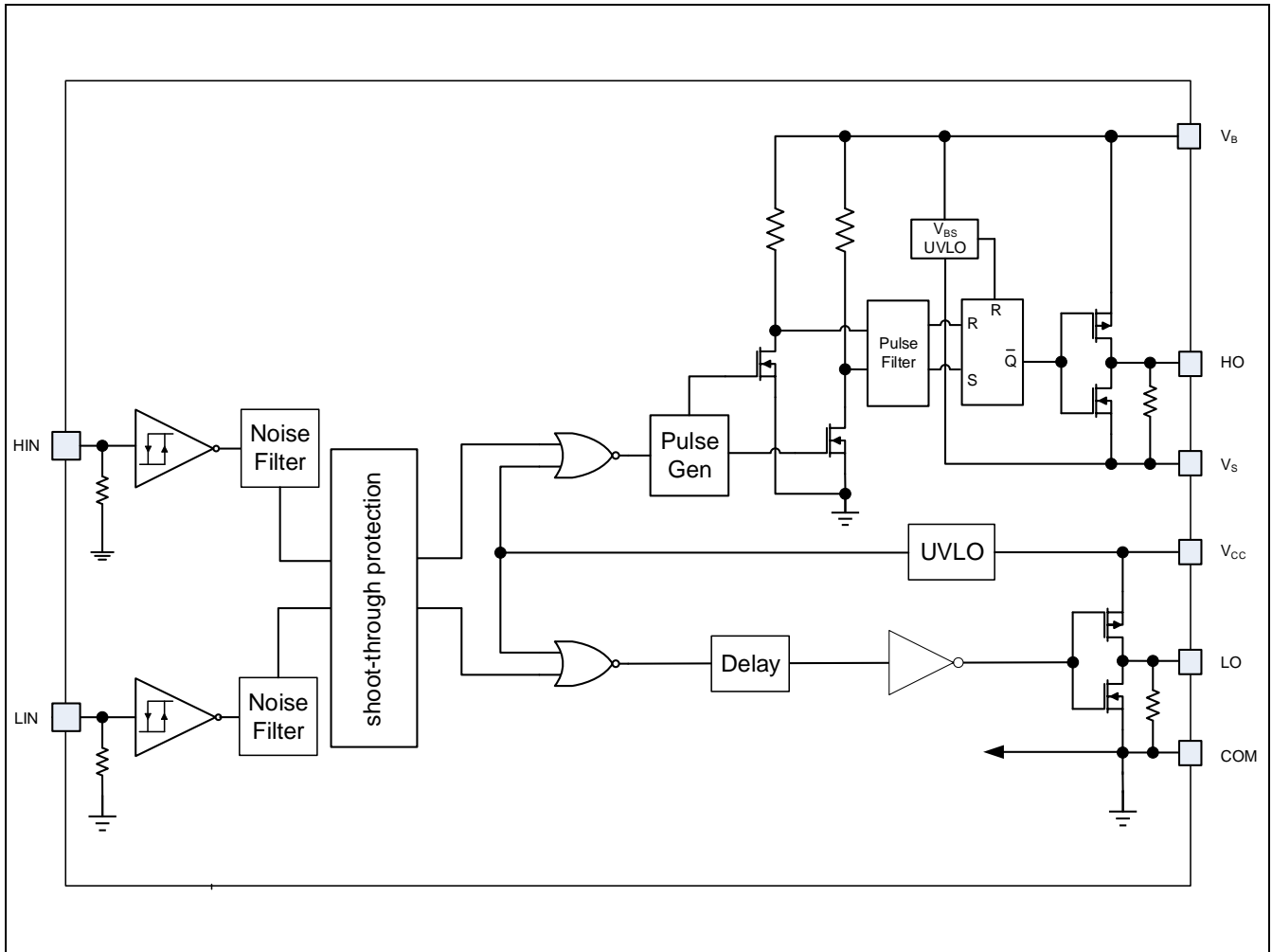

ABSOLUTE MAXIMUM RATINGS

Symbol	Definition	Min.	Max.	Units
V _B	High-side floating absolute voltage	-0.3	225	V
V _S	High-side floating supply offset voltage	V _B - 25	V _B + 0.3	
V _{HO}	High-side floating output voltage	V _S - 0.3	V _B + 0.3	
V _{CC}	Low-side and logic fixed supply voltage	-0.3	25	
V _{LO}	Low-side output voltage	-0.3	V _{CC} + 0.3	
V _{IN}	Logic input voltage (HIN & LIN)	-0.3	V _{CC} + 0.3	
dV _S /dt	Allowable offset supply voltage transient	---	50	V/ns
P _D	Package power dissipation @ T _A ≤ +25°C	---	0.625	W
θ _{JA}	Thermal resistance, junction to ambient	---	200	°C/W
T _J	Junction temperature	---	150	°C
T _S	Storage temperature	-55	150	
T _L	Lead temperature (soldering, 10 seconds)	---	300	

Note: Absolute maximum ratings indicate sustained limits beyond which damage to the device may occur. All voltage parameters are absolute voltages referenced to COM. The thermal resistance and power dissipation ratings are measured under board mounted and still air conditions.

RECOMMENDED OPERATION CONDITIONS

Symbol	Definition	Min.	Max.	Units
V _B	High-side floating absolute voltage	V _S + 10	V _S + 20	V
V _S	High-side floating supply offset voltage		200	
V _{HO}	High-side floating output voltage	V _S	V _B	
V _{CC}	Low-side and logic fixed supply voltage	10	20	
V _{LO}	Low-side output voltage	0	V _{CC}	
V _{IN}	Logic input voltage (HIN & LIN)	0	V _{CC}	
T _A	Ambient temperature	- 40	125	°C

Note: The input/output logic timing diagram is shown in Figure 1. For proper operation the device should be used within the recommended conditions. The V_S offset rating is tested with all supplies biased at a 15 V differential.

DYNAMIC ELECTRICAL CHARACTERISTICS

V_{BIAS} (V_{CC} , V_{BS}) = 15 V, C_L = 1000 pF and T_A = 25°C unless otherwise specified.

Symbol	Parameter	Condition	Min.	Typ.	Max.	Unit
t_{on}	Turn-on propagation delay	$V_S = 0$ V	---	160	220	ns
t_{off}	Turn-off propagation delay	$V_S = 0$ V	---	220	280	
t_r	Turn-on rise time		---	70	170	
t_f	Turn-off fall time		---	35	90	
MT	Delay matching, HS & LS turn-on/off		---	---	60	

STATIC ELECTRICAL CHARACTERISTICS

V_{BIAS} (V_{CC} , V_{BS}) = 15 V and T_A = 25°C unless otherwise specified. The V_{IN} , V_{TH} , and I_{IN} parameters are referenced to COM and are applicable to all logic input leads: HIN and LIN. The V_O and I_O parameters are referenced to COM and are applicable to the respective output leads: HO or LO.

Symbol	Parameter	Condition	Min.	Typ.	Max.	Unit
V_{IH}	Logic "1" input voltage	$V_{CC} = 10$ V to 20V	2.5	---	---	V
V_{IL}	Logic "0" input voltage		---	---	0.8	
V_{OH}	High level output voltage, $V_{BIAS} - V_O$	$I_O = 2$ mA	---	0.05	0.2	
V_{OL}	Low level output voltage, V_O		---	0.02	0.1	
I_{LK}	Offset supply leakage current	$V_B = V_S = 600$ V	---	---	50	
I_{QBS}	Quiescent V_{BS} supply current	$V_{IN} = 0$ V	---	60	78	
I_{QCC}	Quiescent V_{CC} supply current		---	230	280	
I_{IN+}	Logic "1" input bias current	$V_{IN} = 5$ V	---	8	15	
I_{IN-}	Logic "0" input bias current	$V_{IN} = 0$ V	---	---	5	
V_{CCUV+} V_{BSUV+}	V_{CC} & V_{BS} supply undervoltage positive going threshold		8	8.9	9.8	V
V_{CCUV-} V_{BSUV-}	V_{CC} & V_{BS} supply undervoltage negative going threshold		7.4	8.2	9	
I_{O+}	Output high short circuit pulsed current	$V_O = 15$ V, $V_{IN} =$ Logic "1", $PW \leq 10$ μ s	130	290		mA
I_{O-}	Output low short circuit pulsed current	$V_O = 0$ V, $V_{IN} =$ Logic "0", $PW \leq 10$ μ s	270	600		

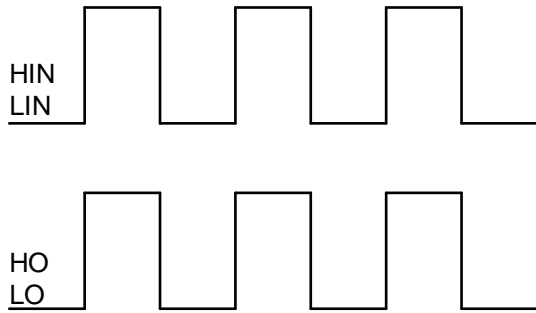

Figure 1. Input/Output Timing Diagram

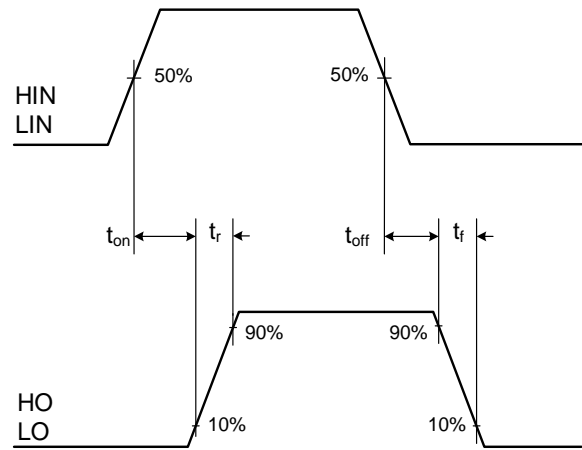

Figure 2. Switching Time Waveform

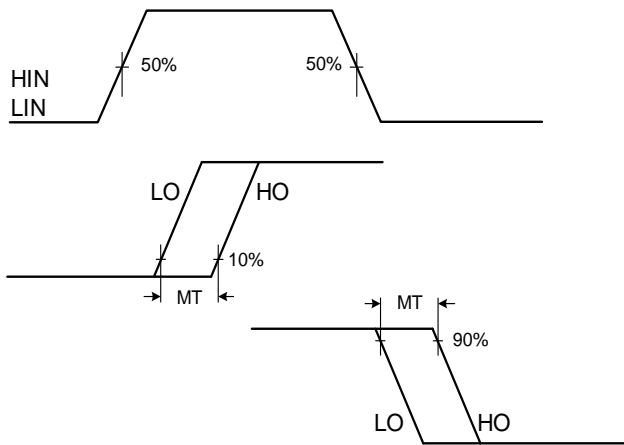

Figure 3. Delay Matching Waveform

TYPICAL PERFORMANCE CHARACTERISTICS

V_{BIAS} (V_{CC} , V_{BS}) = 15 V, and T_A = 25°C unless otherwise specified.

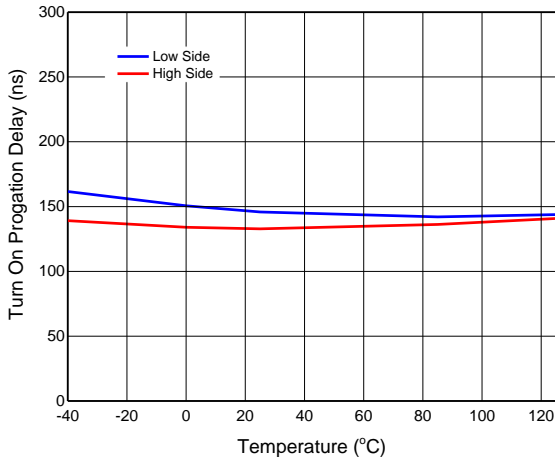

Figure 4. Turn On Delay vs. Temperature

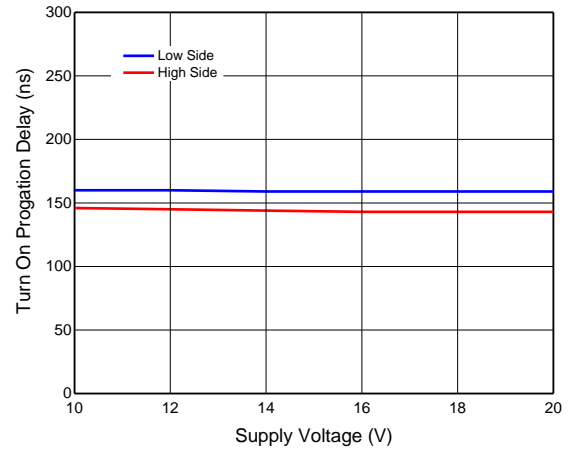

Figure 5. Turn On Delay vs. Supply Voltage

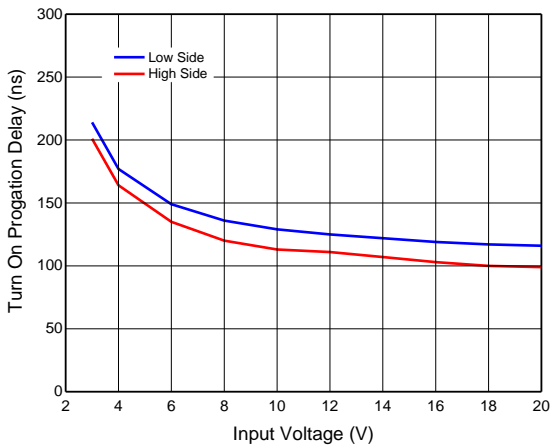

Figure 6. Turn On Delay vs. Input Voltage

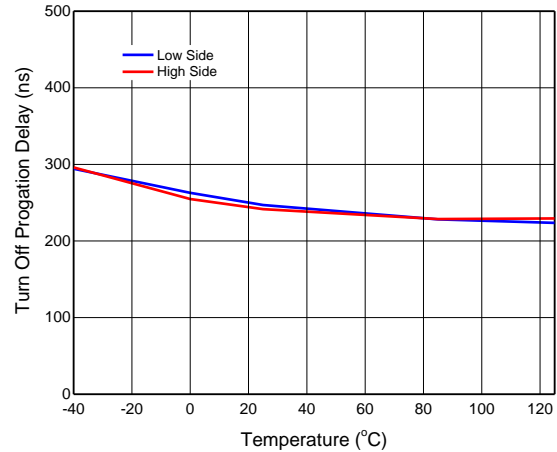

Figure 7. Turn Off Delay vs. Temperature

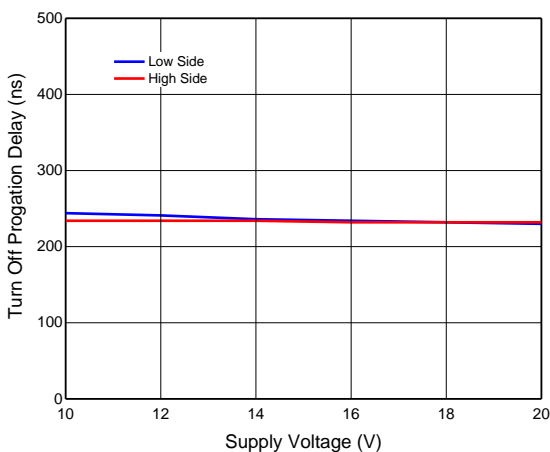

Figure 8. Turn Off Delay vs. Supply Voltage

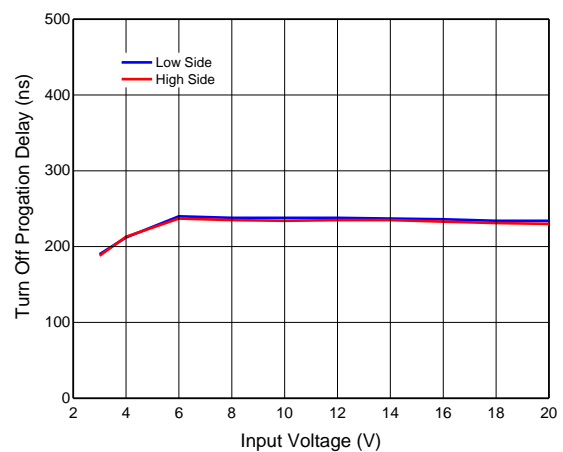

Figure 9. Turn Off Delay vs. Input Voltage

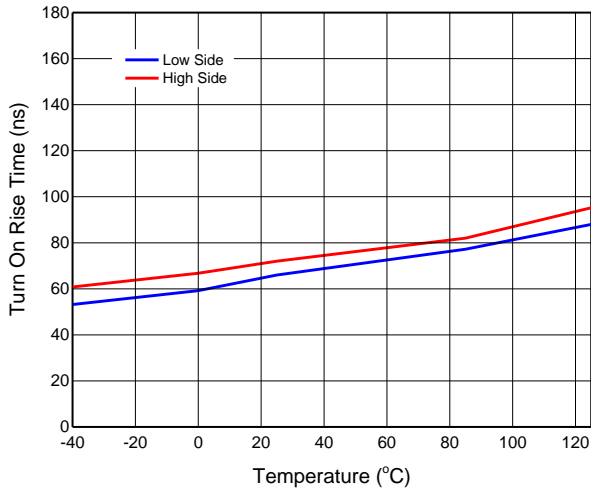

Figure 10. Turn On Rise Time vs. Temperature

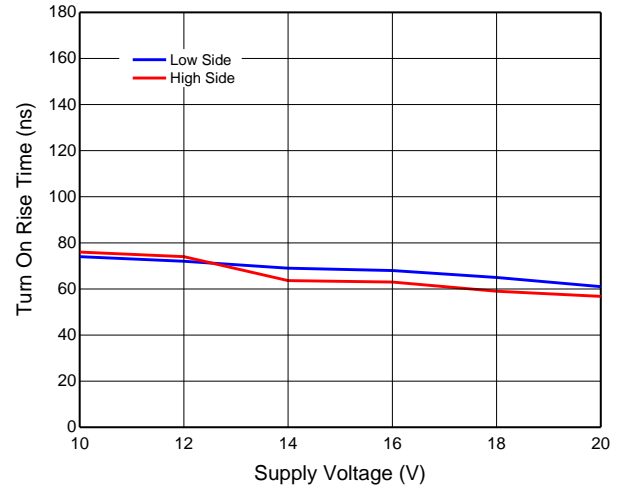

Figure 11. Turn On Rise Time vs. Supply Voltage

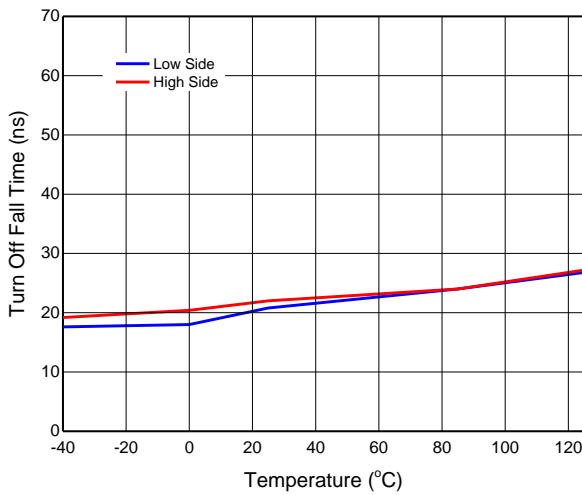

Figure 12. Turn Off Fall Time vs. Temperature

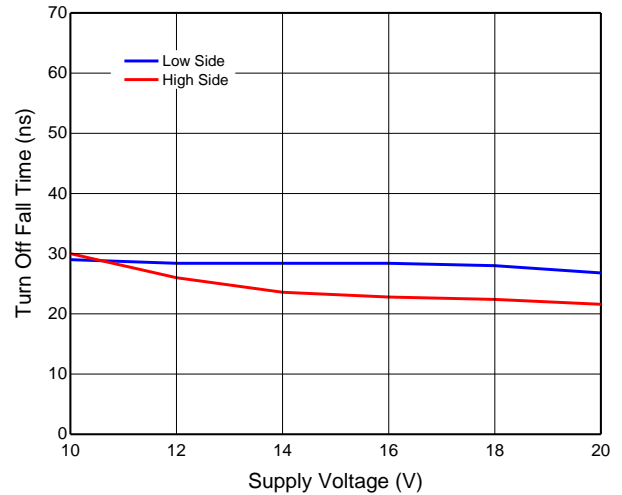

Figure 13. Turn Off Fall Time vs. Supply Voltage

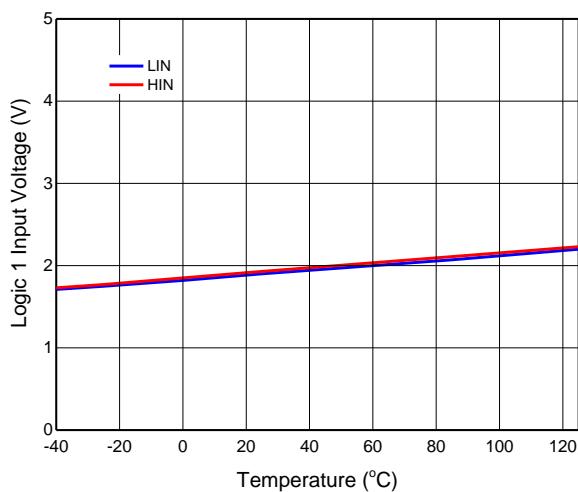

Figure 14. Logic "1" Input Voltage vs. Temperature

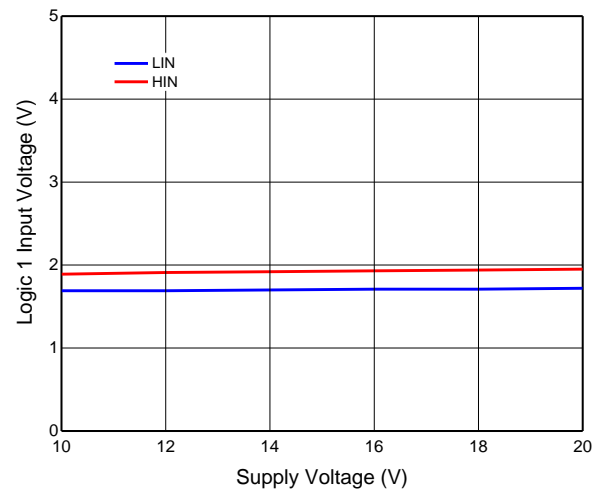

Figure 15. Logic "1" Input Voltage vs. Supply Voltage

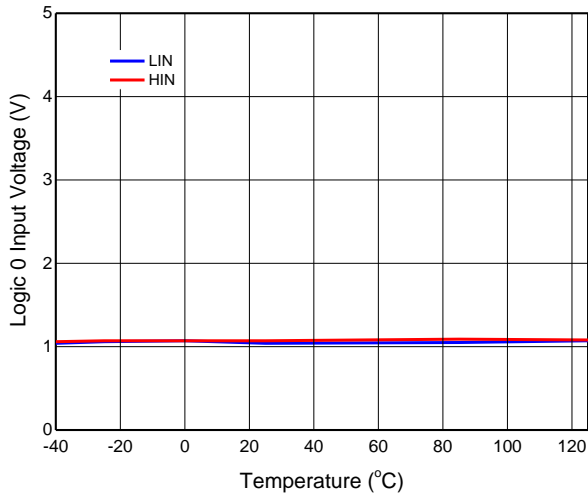

Figure 16. Logic "0" Input Voltage vs. Temperature

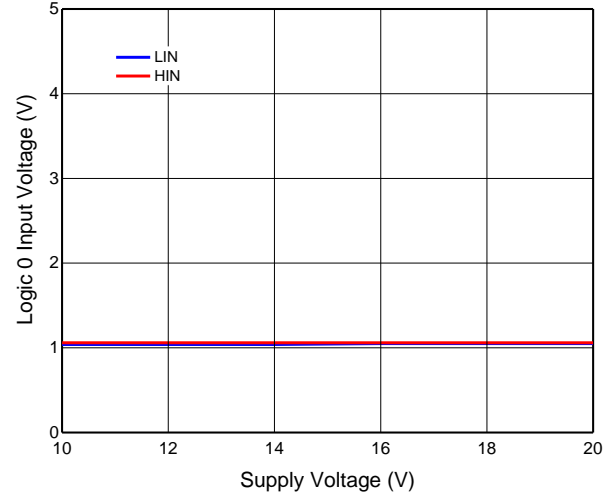

Figure 17. Logic "0" Input Voltage vs. Supply Voltage

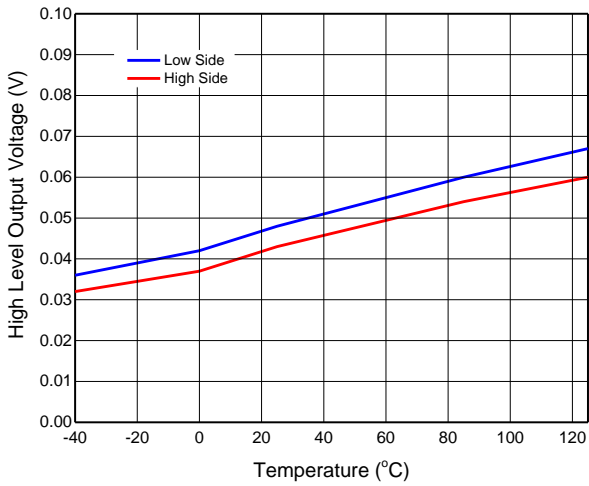

Figure 18. High Level Output vs. Temperature

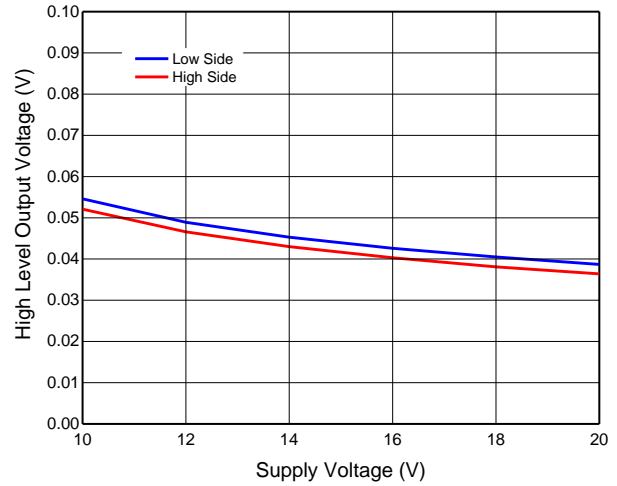

Figure 19. High Level Output vs. Supply Voltage

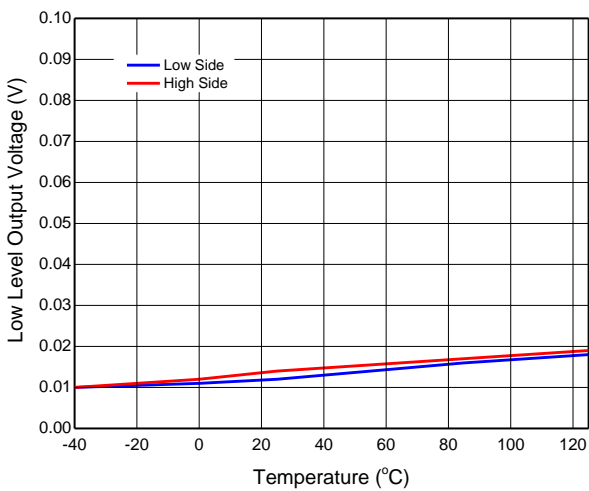

Figure 20. Low Level Output vs. Temperature

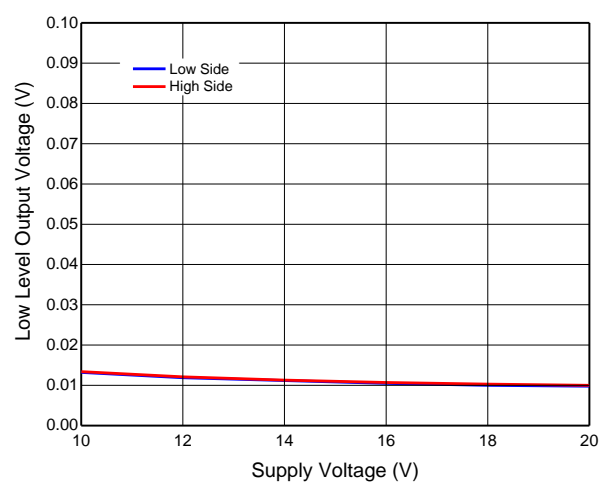

Figure 21. Low Level Output vs. Supply Voltage

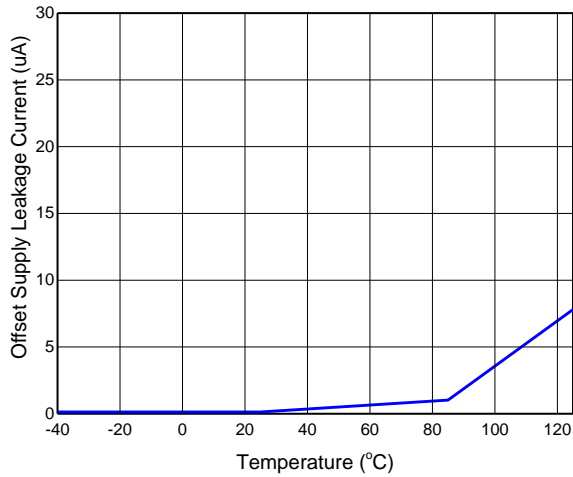

Figure 22. Offset Supply Current vs. Temperature

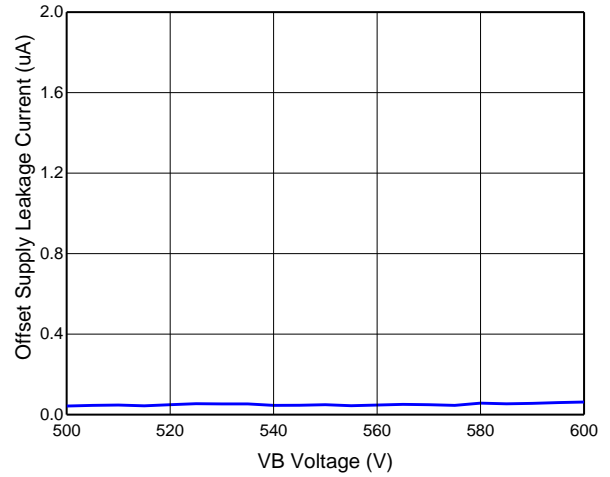

Figure 23. Offset Supply Current vs. VB Voltage

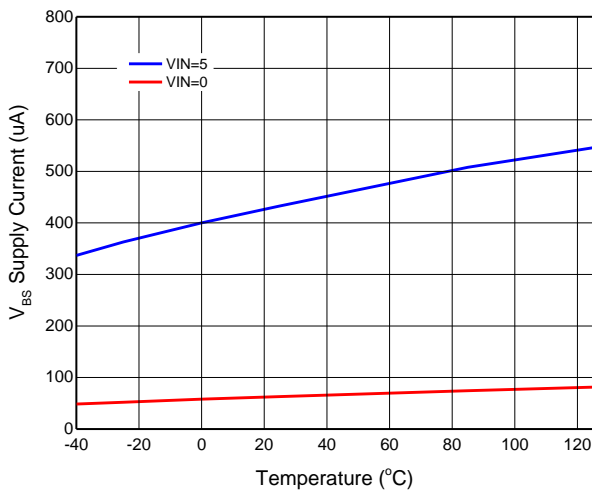

Figure 24. V_{BS} Supply Current vs. Temperature

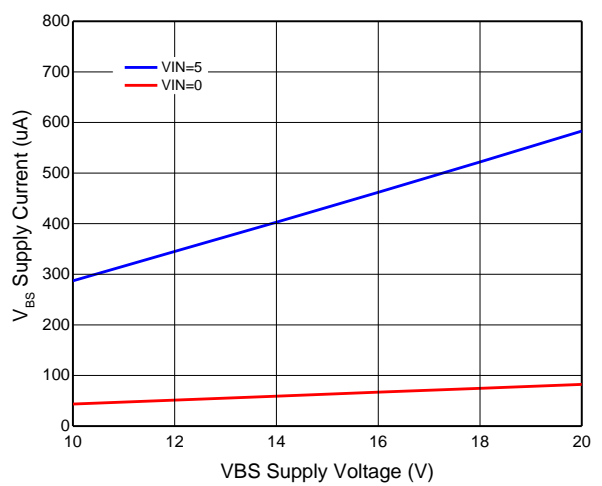

Figure 25. V_{BS} Supply Current vs. Supply Voltage

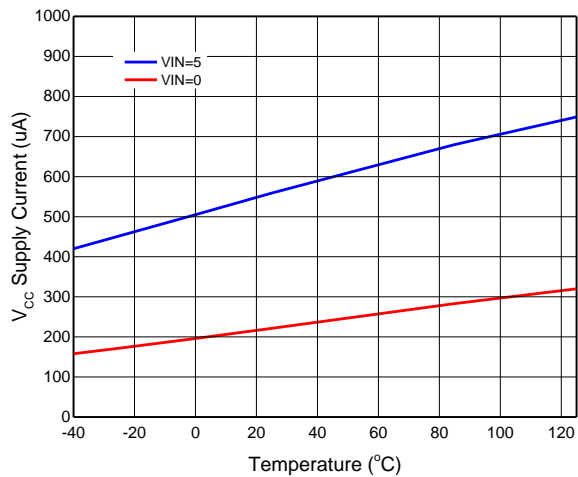

Figure 26. V_{CC} Supply Current vs. Temperature

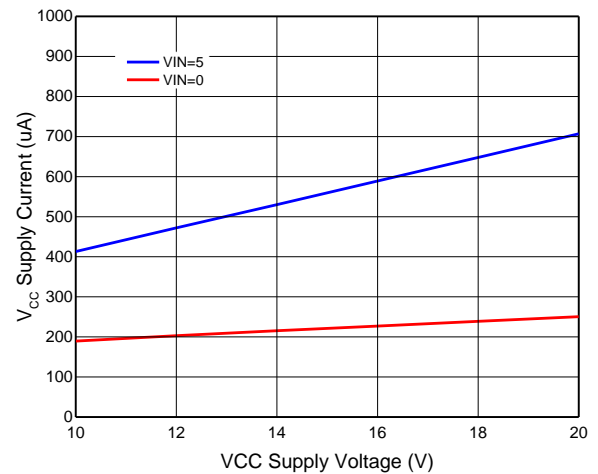

Figure 27. V_{CC} Supply Current vs. Supply Voltage

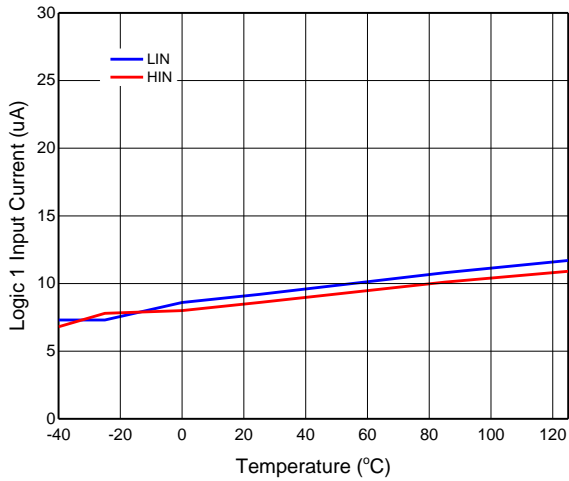

Figure 28. Logic "1" Input Current vs. Temperature

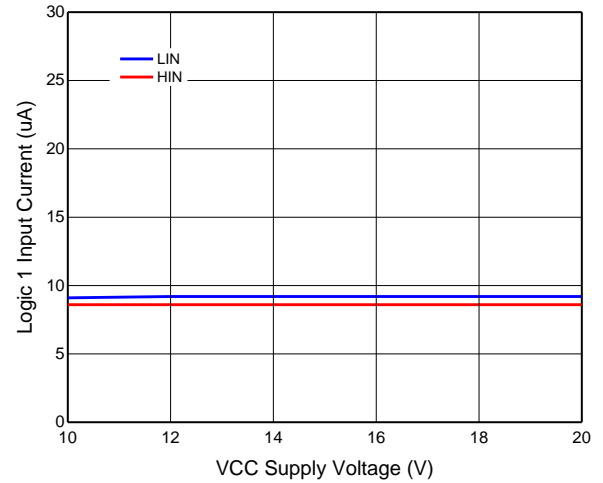

Figure 29. Logic "1" Input Current vs. Supply Voltage

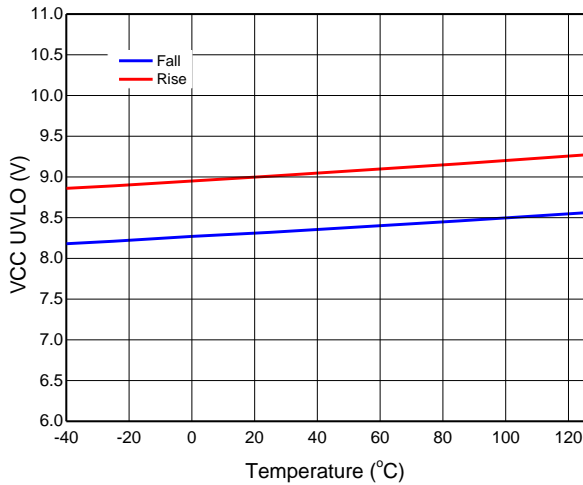

Figure 30. VCC UVLO Threshold vs. Temperature

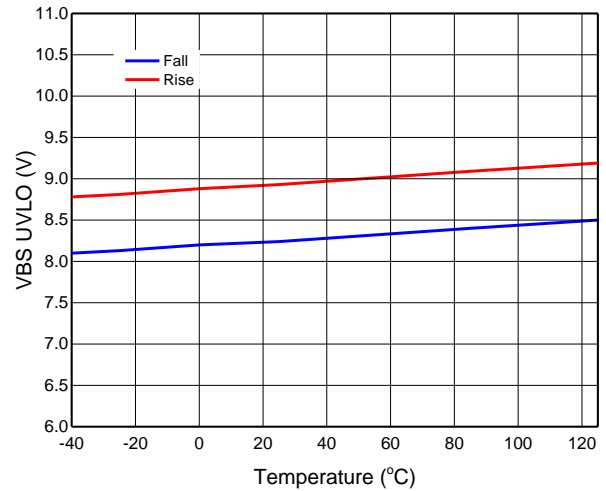

Figure 31. VBS UVLO Threshold vs. Temperature

PACKAGE CASE OUTLINES

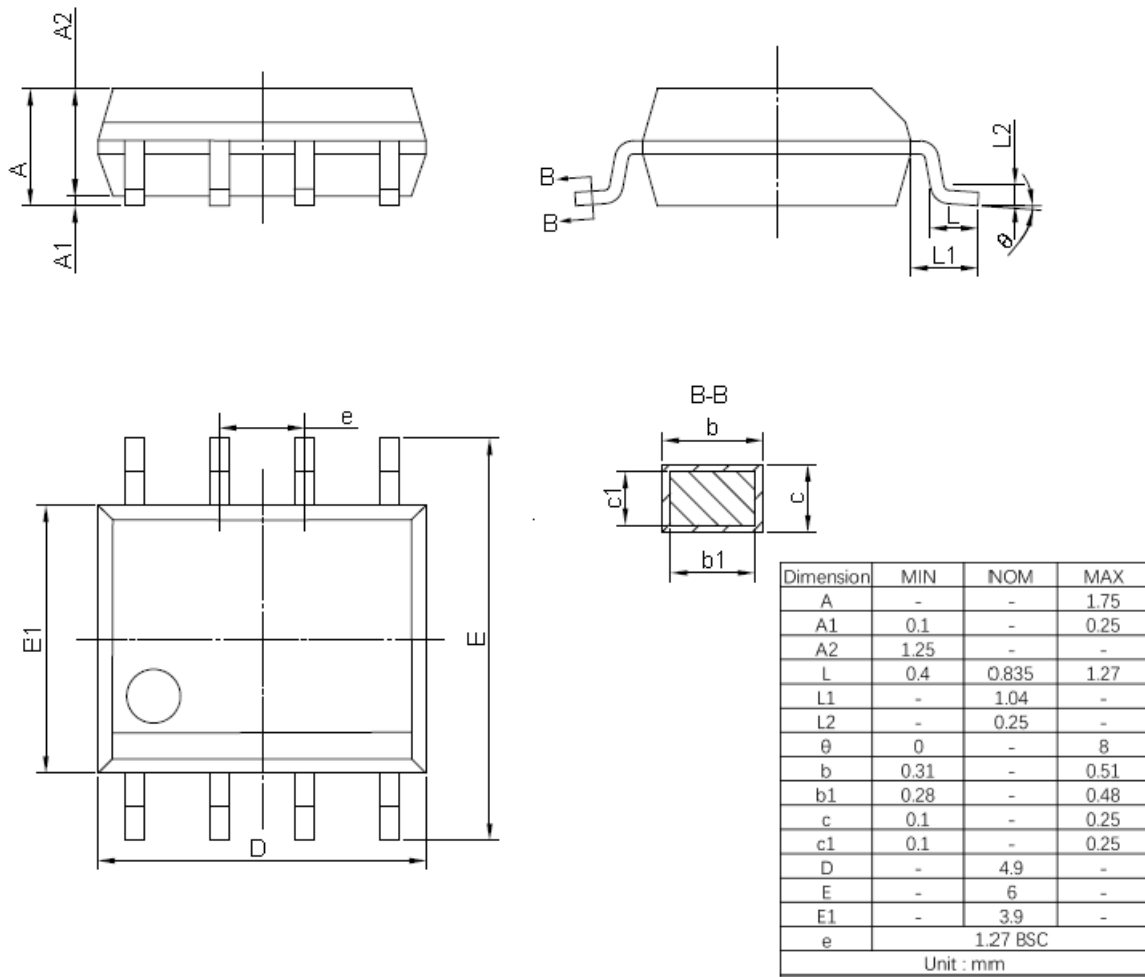

Figure 32. SOP8 Outline Dimensions

REVISION HISTORY

Note: page numbers for previous revisions may differ from page numbers in current version

Page or Item	Subjects (major changes since previous revision)
Rev 1.0 datasheet, 2019-8-29	
Whole document	new company logo released
Page 1	Removed "Fig 1. "
Rev 1.1 datasheet, 2019-10-21	
Page 1	Change "high side and low side driver" to "half-bridge driver"
Page 1	Change "independent" to "dependent"
Rev 1.2 datasheet, 2020-5-15	
Page 5	I _{QBS} and I _{QCC} change
Rev 1.3 datasheet, 2020-9-23	
Page 5	V _{OH} and V _{OL} test condition change I _{IN+} parameter change
Rev 1.4 datasheet, 2021-10-29	
Whole datasheet	Update the Logo and format
Page 1	Remove the PDIP package
Page 2	Remove SLM2005SCA-GT and SLM2005SDA-GT in ordering information
Page 5	Update the V _{OH} , V _{OL} and I _{QCC} in the static electrical characteristics table
Rev 1.5 datasheet, 2022-12-19	
Whole datasheet	Change package name from SOIC-8 to SOP8 and update the package case outlines